

JBL

MultiMedia Series Loudspeakers

Media **System2000**



From the world's premier movie houses, concert stages and recording studios to a PC near you – legendary, high-performance JBL sound that audio professionals have relied on for more than fifty years.

thank you for choosing JBL. For over 50 years, JBL has been involved in every aspect of musical and film recording and reproduction, from live performances to monitoring the recordings you play in your home, car or office.

We're confident that the **JBL loudspeakers** you have chosen will provide every note of enjoyment that you expected and that when you think about purchasing additional audio equipment for your home, car or office, you will once again choose JBL.

Please take a moment to complete the enclosed profile card. It enables us to keep you posted on our latest advancements, and helps us to better understand our customers and to build products that meet their needs and expectations.

JBL Consumer Products

read first! Important Safety Precautions!

CAUTION RISK OF ELECTRIC SHOCK DO NOT OPEN
<p>CAUTION: To prevent electric shock, do not remove the grounding plug on the power cord, or use any plug or extension cord that does not have a grounding plug provided. Make certain that the AC outlet is properly grounded. Do not use an adapter plug with this product.</p>
 <p>The lightning flash with arrowhead symbol, within an equilateral triangle, is intended to alert the user to the presence of unshielded "dangerous voltage" within the product's enclosure that may be of sufficient magnitude to constitute a risk of electric shock to persons.</p>
 <p>The exclamation point within an equilateral triangle is intended to alert the user to the presence of important operating and maintenance (service) instructions in the literature accompanying the appliance.</p>

1. Read Instructions. All the safety and operating instructions should be read before the product is operated.

2. Retain Instructions. The safety and operating instructions should be retained for future reference.

3. Heed Warnings. All warnings on the product and in the operating instructions should be adhered to.

4. Follow Instructions. All operating and use instructions should be followed.

5. Water and Moisture. The product should not be used near water – for example, near a bathtub, washbowl, kitchen sink, laundry tub, in a wet basement, near a swimming pool, and the like.

6. Accessories. Do not place this product on an unstable cart, stand, tripod, bracket, or table.

The product may fall, causing serious injury to a child or an adult, and serious damage to the product. Use only with a cart, stand, tripod, bracket, or table recommended by the manufacturer or sold with the product. Any mounting of the product should follow the manufacturer's instructions, and should use a mounting accessory recommended by the manufacturer.

7. Wall or Ceiling Mounting. The product should be mounted on a wall or ceiling only when and as recommended by the manufacturer.

8. Ventilation. Slots and openings in the cabinet are provided for ventilation and to ensure reliable operation of the product and to protect it from overheating, and these openings must not be blocked or covered. The openings should never be blocked by

placing the product on a bed, sofa, rug, or other similar surface. This product should not be placed in a built-in installation such as a bookcase or rack unless proper ventilation is provided or the manufacturer's instructions have been adhered to.

9. Heat. The product should be situated away from heat sources such as radiators, heat registers, stoves, or other products that produce heat. If placed near an amplifier, check with the manufacturer for applicability.

10. Power Sources. This product should be operated only from the type of power source indicated on the marking label. If you are not sure of the type of power supply to your home, consult your product dealer or local power company. For products intended to operate from battery power or other sources, refer to the operating instructions.

11. Grounding or Polarization. This product may be equipped with a polarized alternating-current line plug (a plug having one blade wider than the other). This plug will fit into the power outlet only one way. This is a safety feature. If you are unable to insert the plug fully into the outlet, try reversing the plug. If the plug should still fail to fit, contact your electrician to replace your obsolete outlet. Do not defeat the safety purpose of the polarized plug.

12. Power-Cord Protection. Power-supply cords should be routed so that they are not likely to be walked on or pinched by items placed upon or against them, paying particular attention to cords at plugs, convenience receptacles, and the point where they exit from the product.

13. Cleaning. Unplug this product from the wall outlet before cleaning. Do not use liquid cleaners or aerosol cleaners. Use a damp cloth for cleaning.

14. Nonuse Periods. The power cord of the product should be unplugged from the outlet when left unused for long periods of time.

15. Lightning. For added protection for this product during a lightning storm, or when it is left unattended and unused for long periods of time, unplug it from the wall outlet and disconnect the antenna or cable system. This will prevent damage to the product due to lightning and power-line surges.

16. Overloading. Do not overload wall outlets, extension cords, or integral convenience receptacles, as this can result in a risk of fire or electric shock.

17. Object and Liquid Entry. Never push objects of any kind into this product through openings, as they may touch dangerous voltage points or short-out parts that could result in a fire or electric shock. Never spill liquid of any kind on the product.

18. Damage Requiring Service. Unplug this product from the wall outlet and refer servicing to qualified service personnel under the following conditions:

a. The power-supply cord or the plug has been damaged; or

b. Objects have fallen onto, or liquid has been spilled into, the product; or

c. The product has been exposed to rain or water; or

d. The product does not operate normally when following the operating instructions. Adjust only those controls that are covered by the operating instructions, as an improper adjustment of other controls may result in damage and will often require extensive work by a qualified technician to restore the product to its normal operation; or

e. The product has been dropped, or the enclosure damaged; or

f. The product does not appear to operate normally or exhibits a marked change in performance.

19. Attachments. Do not use attachments not recommended by the product manufacturer, as they may cause hazards.

20. Replacement Parts. When replacement parts are required, be sure the service technician has used replacement parts specified by the manufacturer or have the same characteristics as the original part. Unauthorized substitutions may result in fire, electric shock or other hazards.

21. Safety Check. Upon completion of any service or repairs to this product, ask the service technician to perform safety checks to determine that the product is in proper operating condition.

22. Servicing. Do not attempt to service this product yourself, as opening or removing covers may expose you to dangerous voltage or other hazards. Refer all servicing to qualified service personnel.

1. Placement

For optimum performance and stereo imaging, slightly angle the speakers toward the listening position.

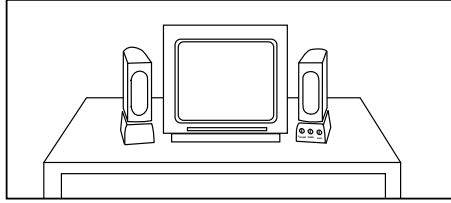

The subwoofer can be placed on the desktop or

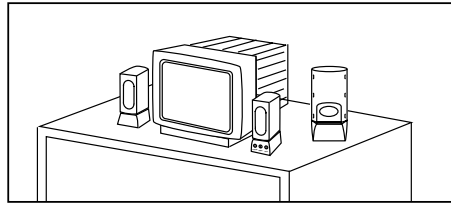

on the floor.

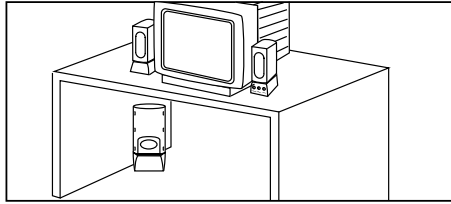

2. Connections

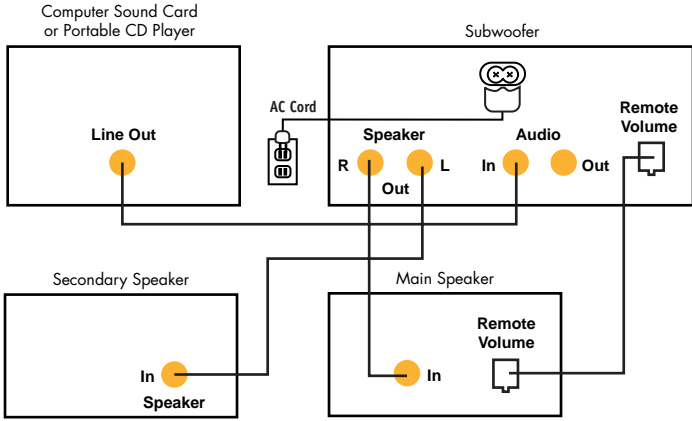

3. Operation

Volume:

To raise the volume level, rotate the *volume* knob clockwise.

To lower the volume level, rotate the *volume* knob counterclockwise.

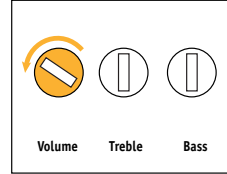
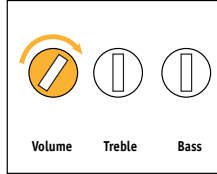

Treble:

To raise the treble level, rotate the *treble* knob clockwise.

To lower the treble level, rotate the *treble* knob counterclockwise.

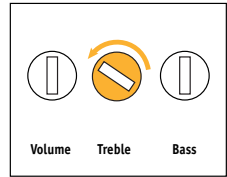
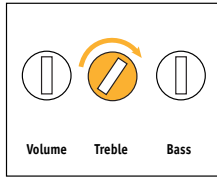

Bass:

To raise the bass level, rotate the *bass* knob clockwise.

To lower the bass level, rotate the *bass* knob counterclockwise.

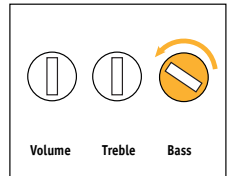
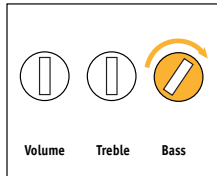

Multiposition directional adjustment

The satellites incorporate a multiposition directional adjustment that allows you to tilt the speakers toward the listening area. This allows you to position the speakers for ideal sound reproduction and imaging.

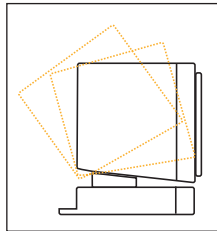

Auto turn-on/turn-off

The Media System2000 features an automatic turn-on/turn-off feature. They will turn off when the source equipment (computer or CD player) has no sound output for approximately fifteen minutes and immediately turn back on when a signal is present.

4. Specifications

Satellites

Maximum Amplifier Output:
15 watts/channel @ 1% THD

Frequency Response:
70Hz – 20kHz

Input Sensitivity: 3V maximum

Input Impedance: 10k ohms

Signal Input Jack:
Stereo mini-connector (1/8")

Subwoofer Output Jack:
Stereo mini-connector (1/8")

Dimensions (H x W x D):
7-5/8 x 3 x 7-7/8"
194 x 76 x 200mm

Weight:
2 lbs./0.9 kg – main
1.5 lbs./0.7 kg – secondary

Subwoofer

Maximum Amplifier Output:
35 watts @ 1% THD

Frequency Response:
50Hz – 120Hz

Input Sensitivity: 3V maximum

Input Impedance: 10k ohms

Signal Input Jack:
Stereo mini-connector (1/8")

Subwoofer Output Jack:
Stereo mini-connector (1/8")

Dimensions (H x W x D):
9-5/8 x 5-1/4 x 10-3/4"
244 x 133 x 273mm

Weight:
7 lbs./3.2 kg



JBL Consumer Products

80 Crossways Park West, Woodbury, NY 11797

8500 Balboa Boulevard, Northridge, CA 91329

1-800-336-4JBL (4525) (USA only) www.jbl.com

© 1997 JBL, Incorporated. JBL is a registered trademark of JBL, Incorporated.

Printed 10/97  Part No. MEDSYS2000OM

 A Harman International Company

